

## 10Gb/s SFP+ BIDI 60km Optical Transceiver Module HXSX-AL6863x / HXSX-AL8663x

### Features

- Up to 11.1Gb/s data rate
- 1270nm DFB laser and APD receiver for HXSX-AL6863x
- 1330nm DFB laser and APD receiver for HXSX-AL8663x
- 2-wire interface with integrated Digital Diagnostic monitoring
- Up to 60km transmission on SMF
- BIDI LC optical connector
- Single +3.3V power supply
- Metal enclosure, for lower EMI
- Maximum power consumption 1.5W
- RoHS-6 compliant and lead-free
- SFF-8472 MSA compliant & SFF-8431
- Operating case temperature  
Commercial: 0 ~ 70°C

### Applications

- Back to Back
- 10GBASE-ER/EW
- 10G Ethernet

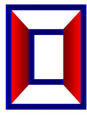

## Part Number Ordering Information

Part Number	Data Rate (Gb/s)	Wavelength (nm)	Transmission Distance(km)	Temperature (°C) (Operating Case)
HXSX-AL6863C	10.3125	1270Tx/1330Rx	60km SMF	0~70 commercial
HXSX-AL8663C	10.3125	1330Tx/1270Rx	60km SMF	0~70 commercial

### 1. Absolute Maximum Ratings

It has to be noted that the operation in excess of any individual absolute maximum ratings might cause permanent damage to this module.

Parameter	Symbol	Min	Max	Unit	Notes
Storage Temperature	T <sub>s</sub>	-40	85	°C	
Power Supply Voltage	V <sub>CC</sub>	-0.5	3.6	V	
Relative Humidity (non-condensation)	RH	5	95	%	
Damage Threshold	TH <sub>d</sub>	0		dBm	

### 2. Recommended Operating Conditions and Power Supply Requirements

Parameter	Symbol	Min	Typical	Max	Unit	Notes
Operating Case Temperature	T <sub>OP</sub>	0		70	°C	commercial
Power Supply Voltage	V <sub>CC</sub>	3.135	3.3	3.465	V	
Data Rate			10.3125		Gb/s	
Control Input Voltage High		2		V <sub>CC</sub>	V	
Control Input Voltage Low		0		0.8	V	
Link Distance (SMF)	D			60	km	9/125um

### 3. General Description

HXSX-AL6863x/ HXSX-AL8663x SFP+ transceiver is designed for use in 10-Gigabit Ethernet links up to 60km over single mode fiber .The module consists of CWDM DFB Laser, APD and Pre-amplifier in a high-integrated optical sub-assembly. Digital diagnostics functions are available via a 2-wire serial interface, as specified in SFF-8472.

HXSX-AL6863x/HXSX-AL8663x transceivers provide a unique enhanced digital diagnostic monitoring interface, which allows real-time access to device operating parameters such as transceiver

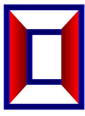

temperature, laser bias current, transmitted optical power, received optical power and transceiver supply voltage. It also defines a sophisticated system of alarm and warning flags, which alerts end-users when particular operating parameters are outside of a factory set normal range.

The SFP+ MSA defines a 256-byte memory map in EEPROM that is accessible over a 2-wire serial interface at the 8 bit address 1010000X (A0h). The digital diagnostic monitoring interface makes use of the 8 bit address 1010001X (A2h), so the originally defined serial ID memory map remains unchanged.

#### 4. Pin Assignment and Pin Description

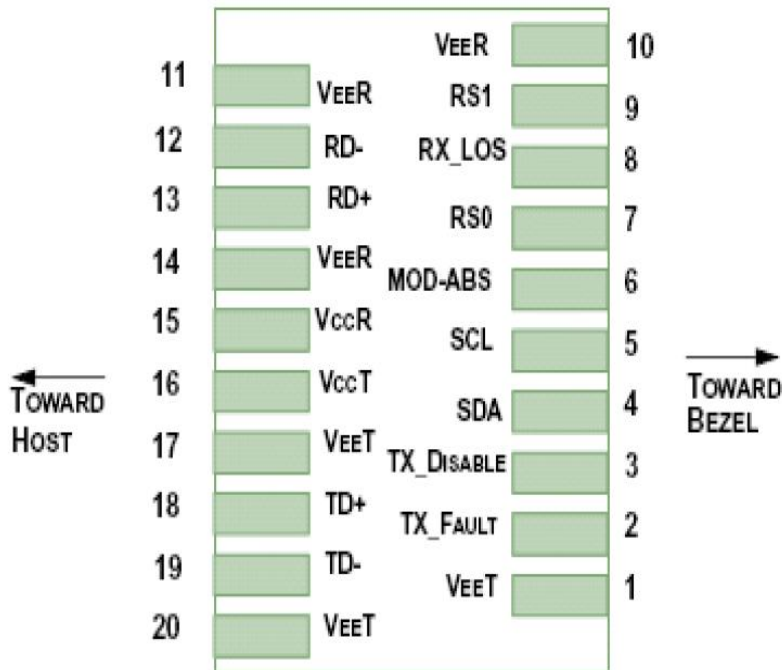
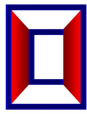

Figure1. Diagram of host board connector block pin numbers and names

Pin	Symbol	Name/Description	Notes
1	$V_{EET}$	Transmitter Ground (Common with Receiver Ground)	1
2	$T_{FAULT}$	Transmitter Fault.	2
3	$T_{DIS}$	Transmitter Disable. Laser output disabled on high or open.	3



4	SDA	2-wire Serial Interface Data Line	4
5	SCL	2-wire Serial Interface Clock Line	4
6	MOD_ABS	Module Absent. Grounded within the module	4
7	RS0	Rate Select 0	5
8	LOS	Loss of Signal indication. Logic 0 indicates normal operation.	6
9	RS1	No connection required	
10	V <sub>EER</sub>	Receiver Ground (Common with Transmitter Ground)	1
11	V <sub>EER</sub>	Receiver Ground (Common with Transmitter Ground)	1
12	RD-	Receiver Inverted DATA out. AC Coupled	
13	RD+	Receiver Non-inverted DATA out. AC Coupled	
14	V <sub>EER</sub>	Receiver Ground (Common with Transmitter Ground)	1
15	V <sub>CCR</sub>	Receiver Power Supply	
16	V <sub>CCT</sub>	Transmitter Power Supply	
17	V <sub>EET</sub>	Transmitter Ground (Common with Receiver Ground)	1
18	TD+	Transmitter Non-Inverted DATA in. AC Coupled.	
19	TD-	Transmitter Inverted DATA in. AC Coupled.	
20	V <sub>EET</sub>	Transmitter Ground (Common with Receiver Ground)	1

Notes:

1. Circuit ground is internally isolated from chassis ground.
2. TFAULT is an open collector/drain output, which should be pulled up with a 4.7kΩ– 10 kΩ resistor on the host board if intended for use. Pull up voltage should be between 2.0V to Vcc + 0.3V. A high output indicates a transmitter fault caused by either the TX bias current or the TX output power exceeding the preset alarm thresholds. A low output indicates normal operation. In the low state, the output is pulled to <0.8V.
3. Laser output disabled on TDIS >2.0V or open, enabled on TDIS <0.8V.
4. Should be pulled up with 4.7kΩ- 10kΩ on host board to a voltage between 2.0V and 3.6V. MOD\_ABS pulls line low to indicate module is plugged in.
5. Internally pulled down per SFF-8431 Rev 4.1.
6. LOS is open collector output. It should be pulled up with 4.7kΩ – 10kΩ on host board to a voltage between 2.0V and 3.6V. Logic 0 indicates normal operation; logic 1 indicates loss of signal.

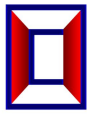

## 5. Electrical Characteristics

The following electrical characteristics are defined over the Recommended Operating Environment unless otherwise specified.

Parameter	Symbol	Min.	Typ.	Max	Unit	Notes
Power Consumption	p			1.5	W	
Supply Current	Icc			450	mA	
<b>Transmitter</b>						
Single-ended Input Voltage Tolerance	Vcc	-0.3		4.0	V	
AC Common Mode Input Voltage Tolerance (RMS)		15			mV	
Differential Input Voltage Swing	Vin,pp	180		700	mVpp	
Differential Input Impedance	Zin	90	100	110	Ohm	1
Transmit Disable Assert Time				10	us	
Transmit Disable Voltage	Vdis	Vcc-1.3		Vcc	V	
Transmit Enable Voltage	Ven	Vee		Vee +0.8	V	2
<b>Receiver</b>						
Differential Output Voltage Swing	Vout,pp	300		850	mVpp	
Differential Output Impedance	Zout	90	100	110	Ohm	3
Data output rise/fall time	Tr/Tf	28			ps	4
LOS Assert Voltage	VlosH	Vcc-1.3		Vcc	V	5
LOS De-assert Voltage	VlosL	Vee		Vee +0.8	V	5
Power Supply Rejection	PSR	100			mVpp	6

Notes:

1. Connected directly to TX data input pins. AC coupled thereafter.
2. Or open circuit.
3. Input 100 ohms differential termination.
4. These are unfiltered 20-80% values.
5. Loss of Signal is LVTTTL. Logic 0 indicates normal operation; logic 1 indicates no signal detected.
6. Receiver sensitivity is compliant with power supply sinusoidal modulation of 20 Hz to 1.5 MHz up to specified value applied through the recommended power supply filtering network.

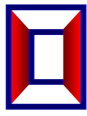

## 6. Optical Characteristics

The following optical characteristics are defined over the Recommended Operating Environment unless otherwise specified.

Parameter	Symbol	Min.	Typical	Max	Unit	Notes
<b>Transmitter</b>						
Center Wavelength	$\lambda_c$	1260	1270	1280	nm	HXSX-AL6863x
		1320	1330	1340	nm	HXSX-AL8663x
Optical Spectral Width	$\Delta\lambda$			1	nm	
Side Mode Suppression Ratio	SMSR	30			dB	
Average Optical Power	$P_{AVG}$	0		5	dBm	
Optical Extinction Ratio	ER	3.5			dB	
Average Launched Power(Laser Off)	$P_{off}$			-30	dBm	
Transmitter Eye Mask	Compliant with IEEE802.3ae					
<b>Receiver</b>						
Center Wavelength	$\lambda_c$	1320	1330	1340	nm	HXSX-AL8663x
		1260	1270	1280	nm	HXSX-AL6863x
Receiver Sensitivity (Average Power)	Sen.			-20	dBm	1
Input Saturation Power (overload)	$P_{sat}$	-6			dBm	
LOS Assert	LOSA	-35			dBm	
LOS De-assert	LOSD			-21	dBm	
LOS Hysteresis	LOSH	0.5			dB	

Notes:

1. Measured with Light source 1270nm@1330nm, ER=3.5dB; BER =<math>10^{-12}</math> @10.3125Gbps, PRBS=2<sup>31</sup>-1 NRZ.

## 7. Digital Diagnostic Functions

The following digital diagnostic characteristics are defined over the Recommended Operating Environment unless otherwise specified. It is compliant to SFF8472 Rev10.2 with internal calibration mode. For external calibration mode please contact our sales staff.

Parameter	Symbol	Min.	Max	Unit	Notes
Temperature monitor absolute error	DMI_Temp	-3	3	degC	Over operating temp
Supply voltage monitor absolute error	DMI_VCC	-0.15	0.15	V	Full operating range
RX power monitor absolute error	DMI_RX	-3	3	dB	
Bias current monitor	DMI_bias	-10%	10%	mA	
TX power monitor absolute error	DMI_TX	-3	3	dB	

## 8. Mechanical Dimensions

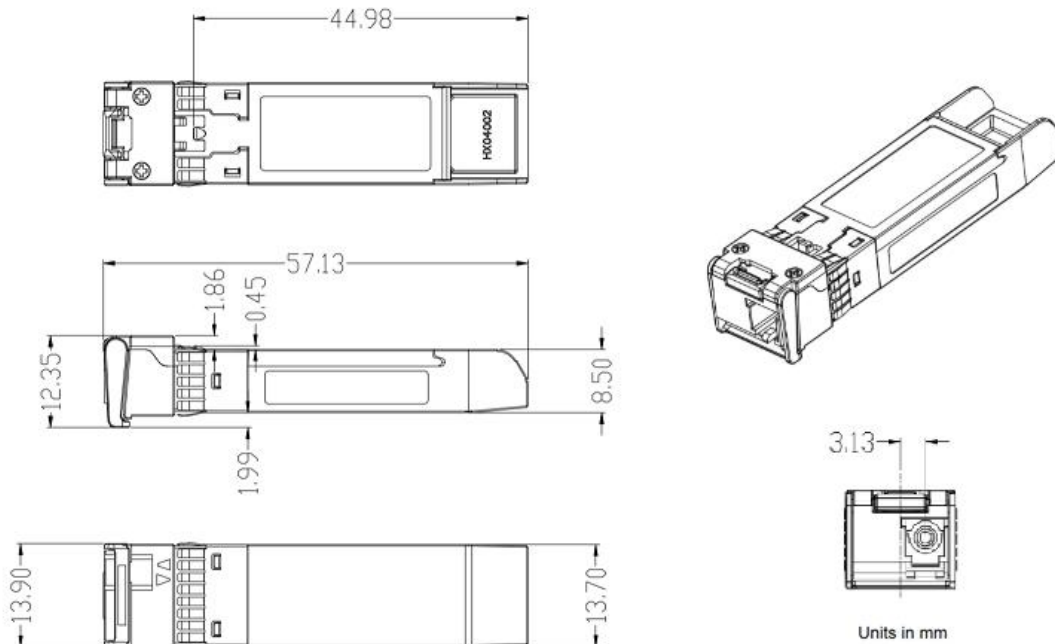

Figure2. Mechanical Outline