













4.25Gb/s CWDM Single-mode SFP Transceiver

HC's SF-CXX42-40D(A) Small Form Factor Pluggable (SFP) transceivers are compatible with the Small Form Factor Pluggable Multi-Sourcing Agreement (MSA). The transceiver consists of five sections: the LD driver, the limiting amplifier, the digital diagnostic monitor, the DFB laser and the PIN receiver. The module data link up to 40KM in 9/125um single mode fiber.







The optical output can be disabled by a TTL logic high-level input of Tx Disable, and the system also can disable the module via I2C. Tx Fault is provided to indicate that degradation of the laser. Loss of signal (LOS) output is provided to indicate the loss of an input optical signal of receiver or the link status with partner. The system can also get the LOS (or Link)/Disable/Fault information via I2C register access.

KEY Features

-  Up to 4.25Gb/s data links
-  DFB laser transmitter and PIN receiver
-  Up to 40km on 9/125µm SMF
-  Hot-pluggable SFP footprint
-  Duplex LC/UPC type pluggable optical interface
-  Low power dissipation
-  Metal enclosure, for lower EMI
-  RoHS compliant and lead-free
-  Single +3.3V power supply
-  Support Digital Diagnostic Monitoring interface
-  Compliant with SFF-8472
-  Case operating temperature
 - Commercial: 0°C to +70°C
 - Industrial: -40°C to +85°C

Application

-  1000 Base-LX Ethernet
-  4xFC at 4.25Gbps
-  2xFC at 2.125 Gbps
-  1xFC at 1.0625Gbps

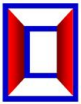

ELECTRIC PIN DESCRIPTIONS

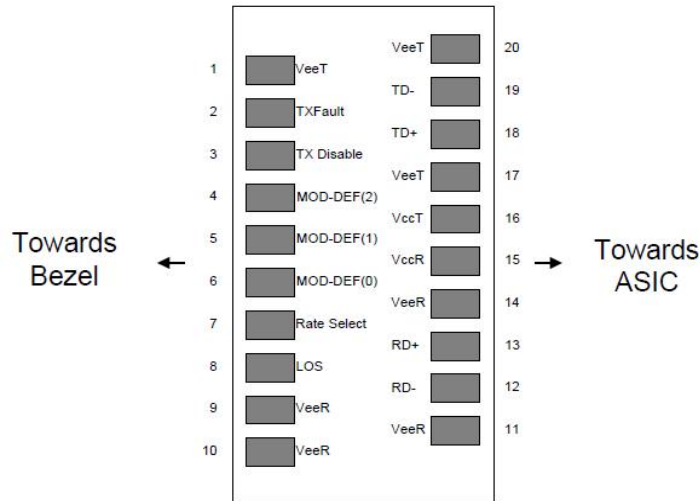
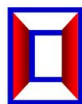

Figure2. Pin out of Connector Block on Host Board

Pin	Symbol	Name/Description	NOTE
1	VEET	Transmitter Ground (Common with Receiver Ground)	1
2	TFAULT	Transmitter Fault.	
3	TDIS	Transmitter Disable. Laser output disabled on high or open.	2
4	MOD_DEF(2)	Module Definition 2. Data line for Serial ID.	3
5	MOD_DEF(1)	Module Definition 1. Clock line for Serial ID.	3
6	MOD_DEF(0)	Module Definition 0. Grounded within the module.	3
7	Rate Select	No connection required	4
8	LOS	Loss of Signal indication. Logic 0 indicates normal operation.	5
9	VEER	Receiver Ground (Common with Transmitter Ground)	1
10	VEER	Receiver Ground (Common with Transmitter Ground)	1
11	VEER	Receiver Ground (Common with Transmitter Ground)	1
12	RD-	Receiver Inverted DATA out. AC Coupled	
13	RD+	Receiver Non-inverted DATA out. AC Coupled	
14	VEER	Receiver Ground (Common with Transmitter Ground)	1
15	VCCR	Receiver Power Supply	
16	VCCT	Transmitter Power Supply	
17	VEET	Transmitter Ground (Common with Receiver Ground)	1
18	TD+	Transmitter Non-Inverted DATA in. AC Coupled.	
19	TD-	Transmitter Inverted DATA in. AC Coupled.	
20	VEET	Transmitter Ground (Common with Receiver Ground)	1

Notes:

- Circuit ground is internally isolated from chassis ground.
- Laser output disabled on TDIS >2.0V or open, enabled on TDIS <0.8V.
- Should be pulled up with 4.7k - 10kohms on host board to a voltage between 2.0V and 3.6V. MOD_DEF (0) pulls line low to indicate module is plugged in.
- This is an optional input used to control the receiver bandwidth for compatibility with multiple data rates (most likely Fiber Channel 1x and 2x Rates). If implemented, the input will be internally pulled down with > 30kΩ resistor. The input states are:
 Low (0 – 0.8V): Reduced Bandwidth
 (>0.8, < 2.0V): Undefined
 High (2.0 – 3.465V): Full Bandwidth
 Open: Reduced Bandwidth
- LOS is open collector output should be pulled up with 4.7k - 10kohms on host board to a voltage between 2.0V and 3.6V. Logic 0 indicates normal operation; logic 1 indicates loss of signal.



Absolute Maximum Ratings

Parameter	Symbol	Min.	Typ.	Max.	Unit	Note
Storage Temperature	T _s	-40		85	°C	
Relative Humidity	RH	5		95	%	
Power Supply Voltage	V _{cc}	-0.5		4	V	
Signal Input Voltage		-0.3		V _{cc} +0.3	V	
Receiver Damage Threshold		5			dBm	

Recommended Operating Conditions

Parameter	Symbol	Min.	Typ.	Max.	Unit	Note
Case Operating Temperature	T _{case}	0		70	°C	Commercial
		-40		85	°C	Industrial
Power Supply Voltage	V _{cc}	3.13	3.3	3.47	V	
Power Supply Current	I _{cc}			300	mA	
Power Supply Noise Rejection				100	mVp-p	100Hz to 1MHz
Data Rate			4.25/4.25		Gbps	TX Rate/RX Rate
Transmission Distance				40	KM	
Coupled Fiber	Single mode fiber					9/125um SMF

Specification of Transmitter

Parameter	Symbol	Min.	Typ.	Max.	Unit	Note
Average Output Power	PO	-1		4	dBm	Note (1)
Extinction Ratio	ER	6			dB	
Center Wavelength	λ _C	(1XX0)-10	1XX0	(1XX0)+10	nm	DFBLaser Note (2)
Side Mode Suppression Ratio	SMSR	30			dB	
Spectrum Bandwidth(-20dB)	σ			1	nm	
Transmitter OFF Output Power	POff			-45	dBm	
Differential Line Input Impedance	RIN	90	100	110	Ohm	
Output Eye Mask	Compliant with G.957 (class 1 laser safety)					

Note:

(1): Measure at 2²³-1 NRZ PRBS pattern

(2): "XX" is: 27,29,31,33,35,37,39,41,43,45,47,49,51,53,55,57,59 and 61

(3): Transmitter eye mask definition

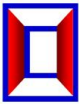

Specification of Receiver

Parameter	Symbol	Min.	Typ.	Max.	Unit	Note
Input Optical Wavelength	λ IN	1270		1610	nm	
Receiver Sensitivity	PIN			-18	dBm	Note (1)
Input Saturation Power (Overload)	PSAT	0.5			dBm	
LOS De-assert	LOSD			-19	dBm	
LOS Assert	LOSA	-30			dBm	Note (2)
LOS Hysteresis		0.5	2	6	dB	

Notes:

- (1): Measured with Light source 1XX0 nm, ER=8.2dB; BER = $<10^{-12}$ @PRBS=2²³-1 NRZ, "XX" is:
27,29,31,33,35,37,39,41,43,45,47,49,51,53,55,57,59 and 61
- (2): When LOS de-asserted, the RX data+/- output is High-level (fixed)

Electrical Interface Characteristics

Parameter	Symbol	Min.	Typ.	Max.	Unit	Note
Transmitter						
Total Supply Current	I _{CC}			A	mA	Note (1)
Transmitter Disable Input-High	V _{DISH}	2		V _{CC} +0.3	V	
Transmitter Disable Input-Low	V _{DISL}	0		0.8	V	
Transmitter Fault Input-High	V _{TxFH}	2		V _{CC} +0.3	V	
Transmitter Fault Input-Low	V _{TxFL}	0		0.8	V	
Receiver						
Total Supply Current	I _{CC}			B	mA	Note (1)
LOSS Output Voltage-High	V _{LOSH}	2		V _{CC} +0.3	V	LVTTTL
LOSS Output Voltage-Low	V _{LOSL}	0		0.8	V	

Note(1): A (TX) + B (RX) = 360mA

(Not include termination circuit)

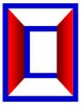

Digital Diagnostic Functions

HC SF-CXX42-40D(A) transceivers support the 2-wire serial communication protocol as defined in the SFP MSA. It is very closely related to the E2PROM defined in the GBIC standard, with the same electrical specifications.

The standard SFP serial ID provides access to identification information that describes the transceiver's capabilities, standard interfaces, manufacturer, and other information.

Additionally, HC SFP transceivers provide a unique enhanced digital diagnostic monitoring interface, which allows real-time access to device operating parameters such as transceiver temperature, laser bias current, transmitted optical power, received optical power and transceiver supply voltage. It also defines a sophisticated system of alarm and warning flags, which alerts end-users when particular operating parameters are outside of a factory set normal range.

The SFP MSA defines a 256-byte memory map in E2PROM that is accessible over a 2-wire serial interface at the 8 bit address 1010000X (A0h). The digital diagnostic monitoring interface makes use of the 8 bit address 1010001X (A2h), so the originally defined serial ID memory map remains unchanged. The interface is identical to, and is thus fully backward compatible with both the GBIC Specification and the SFP Multi Source Agreement.

The operating and diagnostics information is monitored and reported by a Digital Diagnostics Transceiver Controller (DDTC) inside the transceiver, which is accessed through a 2-wire serial interface. When the serial protocol is activated, the serial clock signal (SCL, Mod Def 1) is generated by the host. The positive edge clocks data into the SFP transceiver into those segments of the E2PROM that are not write-protected. The negative edge clocks data from the SFP transceiver. The serial data signal (SDA, Mod Def 2) is bi-directional for serial data transfer. The host uses SDA in conjunction with SCL to mark the start and end of serial protocol activation. The memories are organized as a series of 8-bit data words that can be addressed individually or sequentially.

Digital diagnostics for the SF-CXX42-40D(A) are internally calibrated by default.



Recommend Circuit Schematic

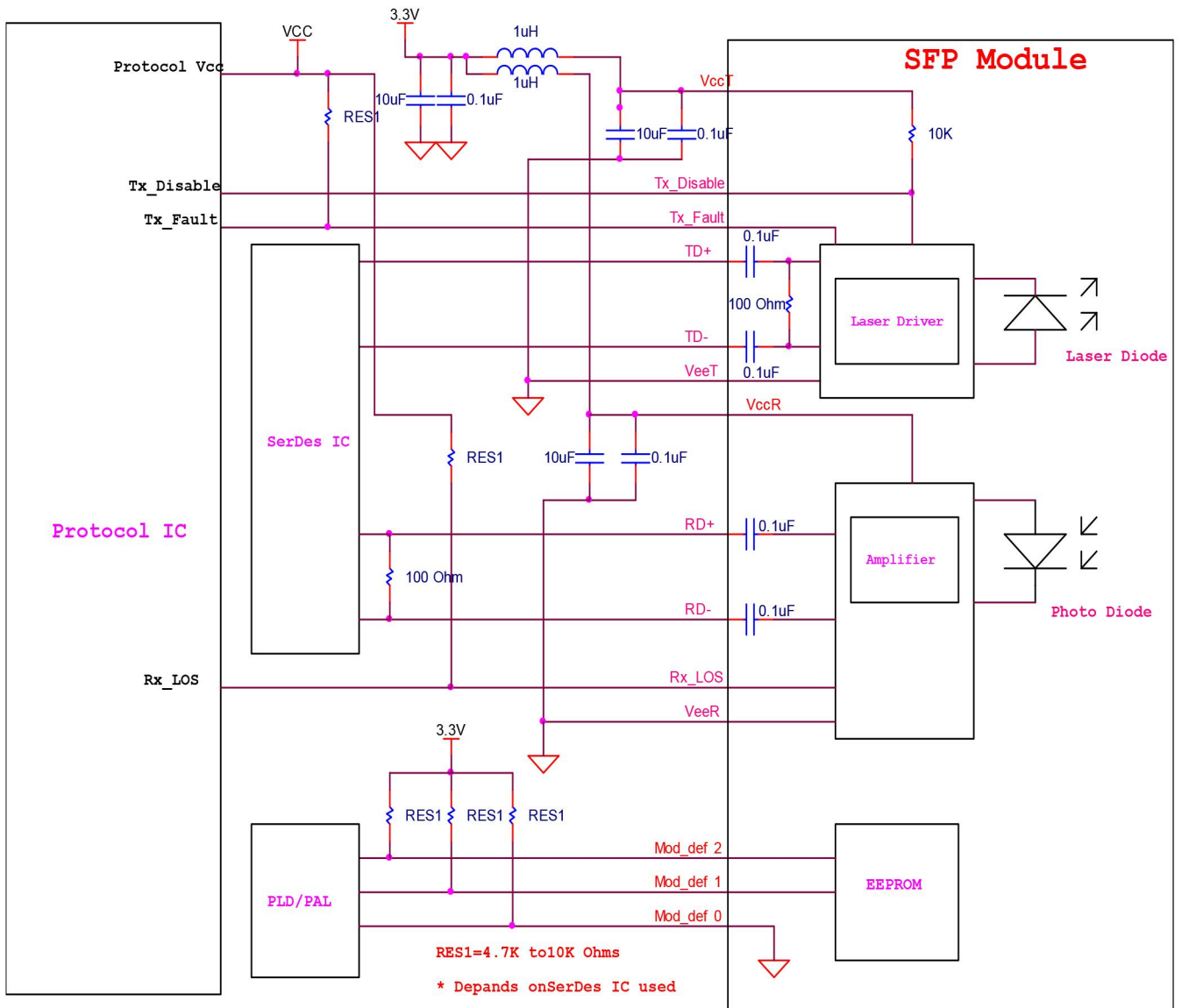

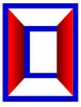

 Mechanical Specifications (Unit: mm)

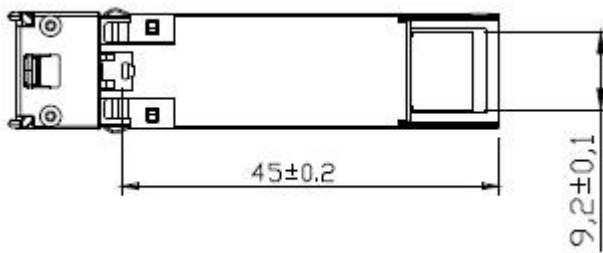
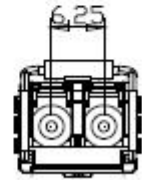
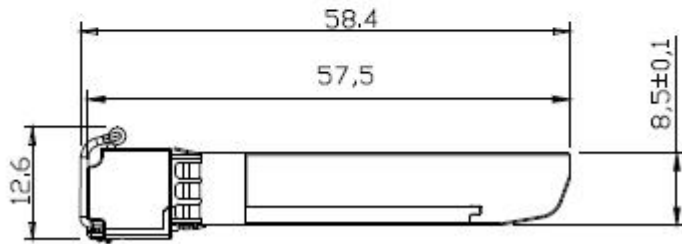
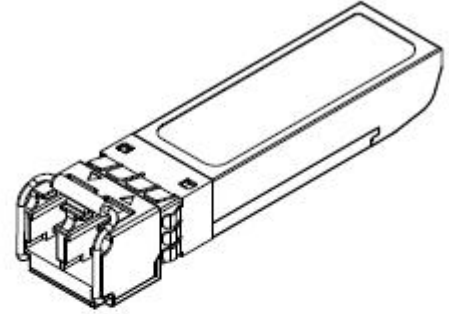
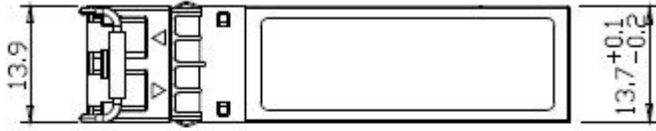

SF-CXX42-40D(A)

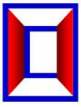

ORDERING INFORMATION

Product part Number	Data Rate (Mbps)	Media	Transmission Distance(km)	Temperature Range (Tcase) (°C)	
SF-CXX42-40D	4250	Single mode fiber	40	0~70	commercial
SF-CXX42-40D A	4250	Single mode fiber	40	-40~85	industrial

Wavelength	xx	Clasp Color Code	Wavelength	xx	Clasp Color Code
1270 nm	27	Gray	1450 nm	45	Brown
1290 nm	29	Gray	1470 nm	47	Gray
1310 nm	31	Gray	1490 nm	49	Purple
1330 nm	33	Purple	1510 nm	51	Blue
1350 nm	35	Blue	1530 nm	53	Green
1370 nm	37	Green	1550 nm	55	Yellow
1390 nm	39	Yellow	1570 nm	57	Orange
1410 nm	41	Orange	1590 nm	59	Red
1430 nm	43	Red	1610 nm	61	Brown