





## Product Description





The 4X4 fiber optic switch connects optical channels by directing or blocking an incoming optical signal into the output fiber. This is achieved using a patent pending optical-to-mechanical configuration and activated via an electrical control signal. Latching version preserves the selected optical path after the drive signal has been removed, while the non-latching versions default to either the open or closed state when power is removed. The switch has integrated electrical position sensors. The new material based advanced design significantly reduces moving part position sensitivity, offering unprecedented high stability as well as unmatched low cost.

## Features

-  Unmatched Low Cost
-  Low Optical Distortions
-  High Isolation
-  High Reliability
-  Epoxy-Free Optical Path



## Applications

-  Channel Blocking
-  Configurable Add/Drop
-  System Monitoring
-  Instrumentation

## Specifications

Parameters	Specifications	Unit
Operating Wavelength	1260~1620(SM)、850(MM)	nm
Insertion Loss	≤1.4	dB
Wavelength Dependent Loss	≤0.40	dB
Polarization Dependent Loss	≤0.05	dB
Temperature Dependent Loss	≤0.20	dB
Return Loss	SM≥50 MM≥30	dB
Cross Talk	SM≥55 MM≥35	dB
Switch Time	≤8	ms
Repeat ability	≤±0.02	dB
Durability	≥10 <sup>7</sup>	times
Operating Voltage	3 or 5	V
Switch Type	Non-Latching/Latching	
Operating Temperature	-20~+70	°C
Storage Temperature	-40~+85	°C
Optical Power	≤500	mw
Dimension	52.7L×37.2W×10.0H	mm

## Pin Configurations

Type	State	Electric Drive				Status Sensor			
4X4		Pin 1	Pin 5	Pin 6	Pin 10	Pin 2-3	Pin 3-4	Pin 7-8	Pin 8-9
Latching	0	--	--	GND	V+	Close	Open	Open	Close
	1	V+	GND	--	--	Open	Close	Close	Open
Non-latching	0	--	--	--	--	Close	Open	Open	Close
	1	V+	--	--	GND	Open	Close	Close	Open

NO.	Optical Route	Relay					
		1	2	3	4	5	6
1	A-1、B-2、C-3、D-4	1	1	1	1	1	1
2	A-1、B-2、C-4、D-3	1	1	1	1	1	0
3	A-1、B-3、C-2、D-4	1	1	1	1	0	1
4	A-1、B-3、C-4、D-2	1	1	1	0	0	1
5	A-1、B-4、C-2、D-3	1	1	1	1	0	0
6	A-1、B-4、C-3、D-2	1	1	1	0	0	0
7	A-2、B-1、C-3、D-4	1	1	0	1	1	1
8	A-2、B-1、C-4、D-3	1	1	0	1	1	0

9	A-2、B-3、C-1、D-4	1	1	0	1	0	1
10	A-2、B-3、C-4、D-1	1	1	0	0	0	1
11	A-2、B-4、C-1、D-3	1	1	0	1	0	0
12	A-2、B-4、C-3、D-1	1	1	0	0	0	0
13	A-3、B-1、C-2、D-4	1	0	1	1	0	1
14	A-3、B-1、C-4、D-2	1	0	1	0	0	1
15	A-3、B-2、C-1、D-4	1	0	0	1	0	1
16	A-3、B-2、C-4、D-1	1	0	0	0	0	1
17	A-3、B-4、C-1、D-2	0	0	1	0	0	1
18	A-3、B-4、C-2、D-1	0	0	0	0	0	1
19	A-4、B-1、C-2、D-3	1	0	1	1	0	0
20	A-4、B-1、C-3、D-2	1	0	1	0	0	0
21	A-4、B-2、C-1、D-3	1	0	0	1	0	0
22	A-4、B-2、C-3、D-1	1	0	0	0	0	0
23	A-4、B-3、C-1、D-2	0	0	1	0	0	0
24	A-4、B-3、C-2、D-1	0	0	0	0	0	0

 **Mechanical Dimensions (Unit:mm)**

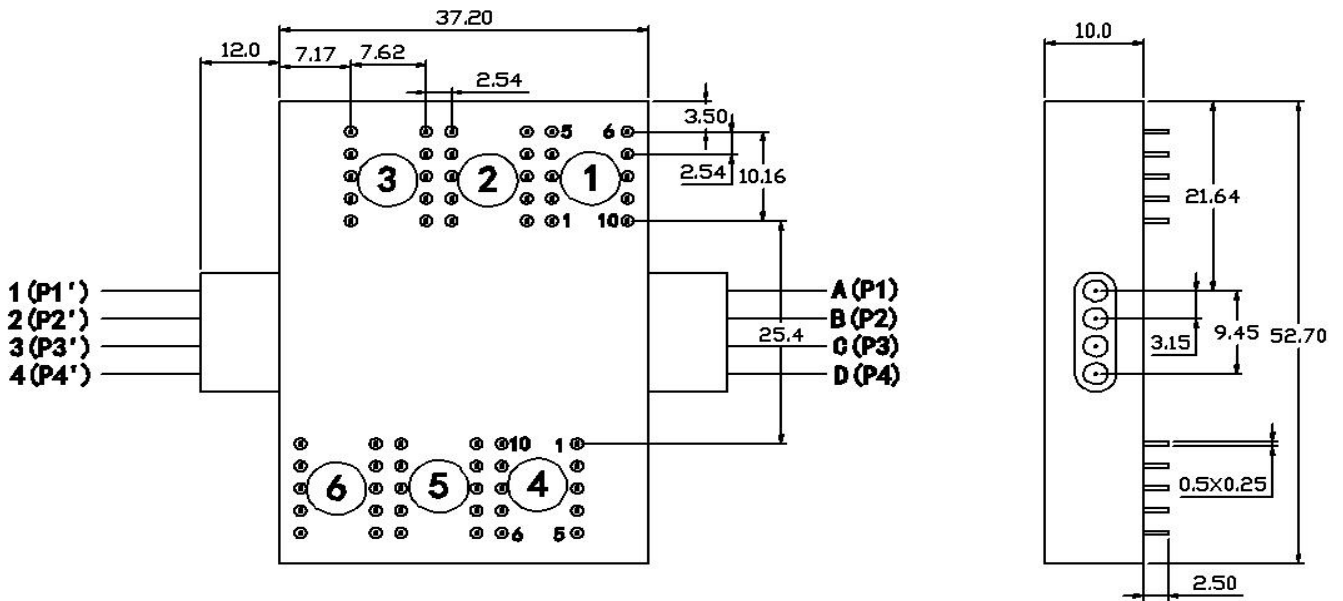

**Optical Route**

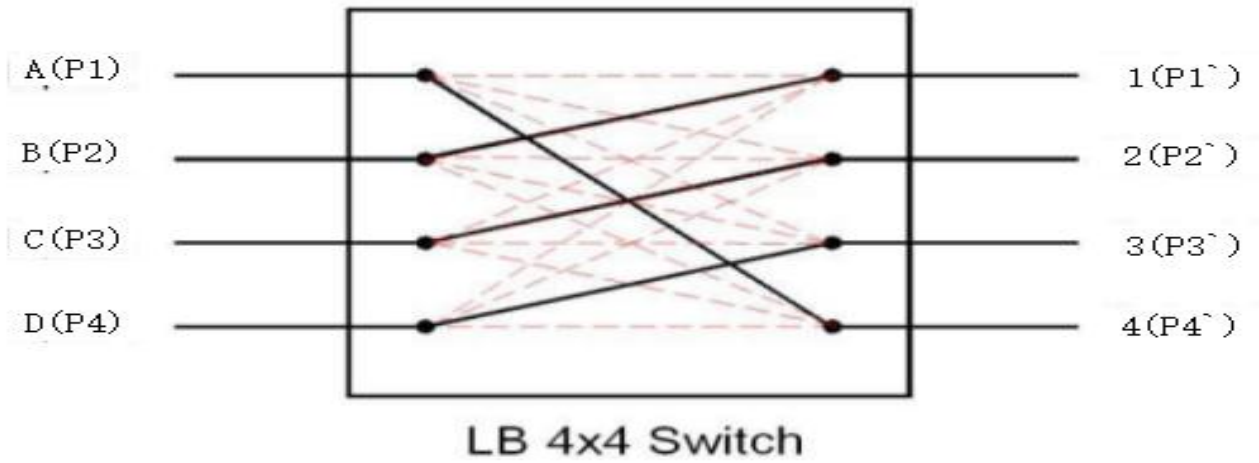

**Ordering Information HC-FSW-4x4-A-B-C-D-E-F-G**

4x4	A	B	C	D	E	F	G
Type	Wavelength	Switch Type	Voltage	Fiber Type	Package	Fiber Length	Connector
00=Special	2=C+L 13=1310 14=1410 15=1550 A=1260-1610 9=1310/1550 8=850 00=Special	1=Latching	3=3V 5=5V	1=SM28 5=50/125 6=62.5/125 00=Special	1=Bare fiber 9=900um tube 00=Special	25=0.25m 5=0.5m 1=1.0m 00=Special	1=None 2=FC/PC 3=FC/APC 4=SC/PV 5=SC/APC 6=ST/PC 7=LC/PC 00=Special